



مجموعة فلورا
FLORA GROUP

WE
BUILD
SUCCESSFUL
COMPANIES





EXECUTIVE MESSAGE

Bader Alsaeed
Executive President

Since the establishment of Flora Group, we have focused on four major success methods: Partnering with world-class, leading market suppliers with high quality solutions in all fields; connecting with our clients and providing them with the best pre-sales and after sales services; always developing and adapting to the market changes; and relying on the best qualified staff. We look forward to provide the best solutions to help prepare Qatar for the World Cup 2022, as well as to realize Qatar National Vision 2030.



Yousuf Al-Muaden
Local Partner

OUR VISION

To stimulate progress and improvement and transform the way business is done... It is not just about products, it is about shaping a better future together.

OUR MISSION

We provide our customers with superior and innovative solutions based on state-of-the-art technology and consistent excellence in service execution, ultimately delivering sustainable growth and profit.

ABOUT US

FLORA GROUP

Founded in 1993, Flora Group has grown to become a group of leading Qatari specialized trading and service companies that offer a large and diversified portfolio of products and end-to-end custom solutions to its customers in Qatar and the middle-east region. Since its creation, the group focused on offering top quality products and services that have made its reputation and ensured customer satisfaction and group success for more than 22 years. We strive to preserve a high level of business ethics characterized by integrity and honesty in all our business actions and throughout all our companies.

Flora Group's business domains span a range of 8 core industries:

- Technology and services
- Security solutions
- Retail solutions
- Food and vegetables trading
- Flowers and flower products
- Construction
- Office furniture
- Medical equipment

Apart from its core industries, Flora Group also monitors opportunities in different sectors, where it has a potential to create value with its unique know-how and experience. For more than 22 years we have built a strong and loyal client base across both the public and private sectors and we will continue to innovate and expand for the continuous satisfaction of our existing and future clients.

MORE THAN
50
PARTNERS
WORLDWIDE

85%
OF THE QATARI
MARKET
SHARE IN
CUSTOMER
EXPERIENCE
MANAGEMENT

MORE THAN
600
CORPORATE
CLIENTS
SATISFIED



ORGANIZATION CHART

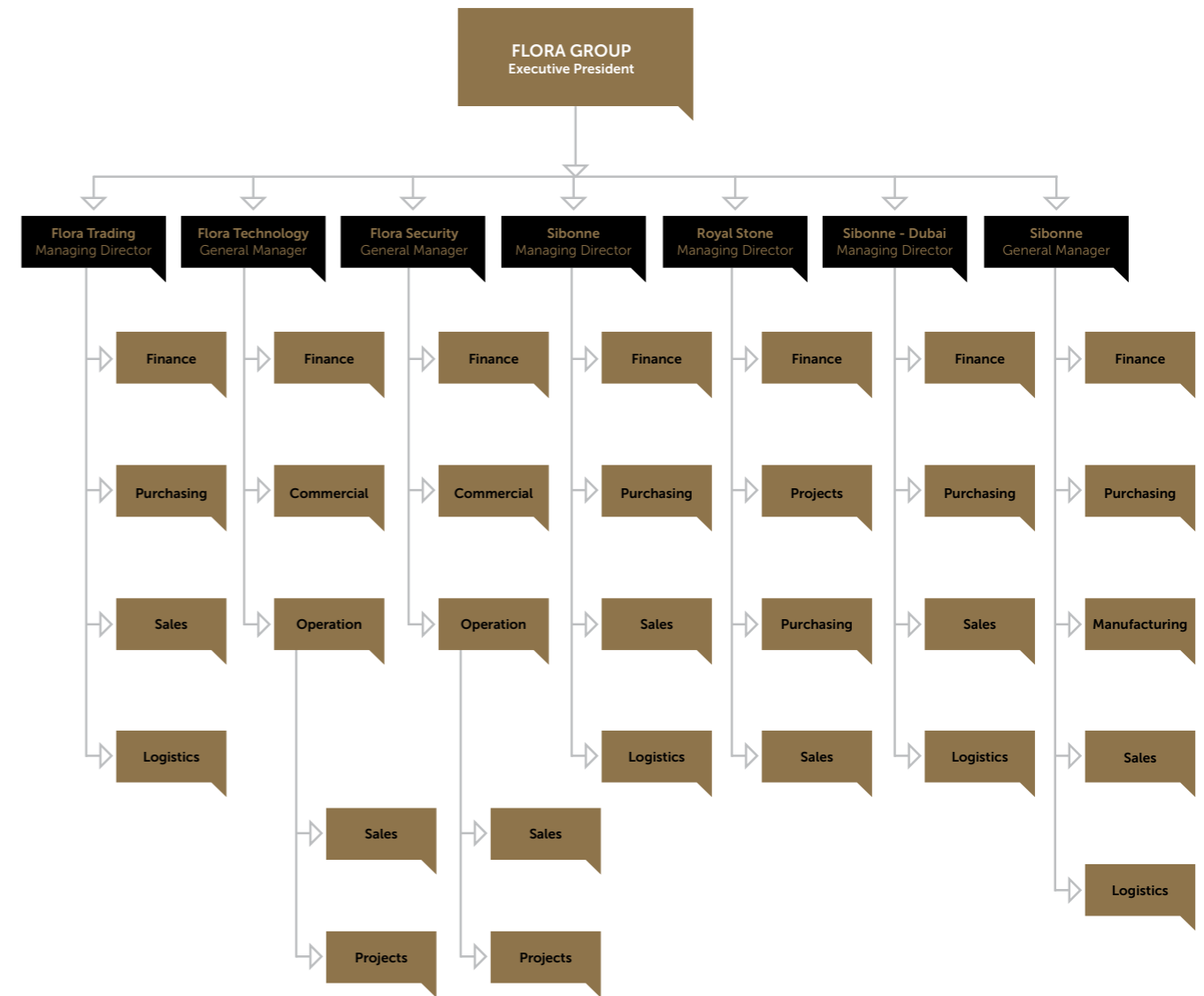

GROUP OF COMPANIES

Flora Group comprises of seven independent entities that together form a dynamic whole sharing the common group values and deep industry expertise and experience to support their development.



مجموعة فلورا
FLORA GROUP

شركة فلورا للتكنولوجيا FLORA TECHNOLOGY CO.

Tel: +974 44311905, Fax: +974 44314133
E-mail: floraqatar@qatar.net.qa

فلورا للأنظمة الأمنية FLORA SECURITY SYSTEMS

Tel: +974 44311905, Fax: +974 44314133
E-mail: floraqatar@qatar.net.qa

مركز فلورا التجاري FLORA TRADING CENTRE

Tel: +974 44607700, Fax: +974 44607701
E-mail: flora@qatar.net.qa

سيبون Si Bonne

Doha

Tel: +974 44607703, Fax: +974 44504480
E-mail: sibonne@qatar.net.qa

سيبون Si Bonne

Dubai

Tel: +974 44607703, Fax: +974 44504480
E-mail: sibonne@qatar.net.qa

سيبون لصناعة المواد الغذائية Si Bonne

Food Stuff Industries

Tel: +974 44607703, Fax: +974 44504480
E-mail: sibonne@qatar.net.qa



Tel: +974 44607703, Fax: +974 44504480
E-mail: sibonne@qatar.net.qa

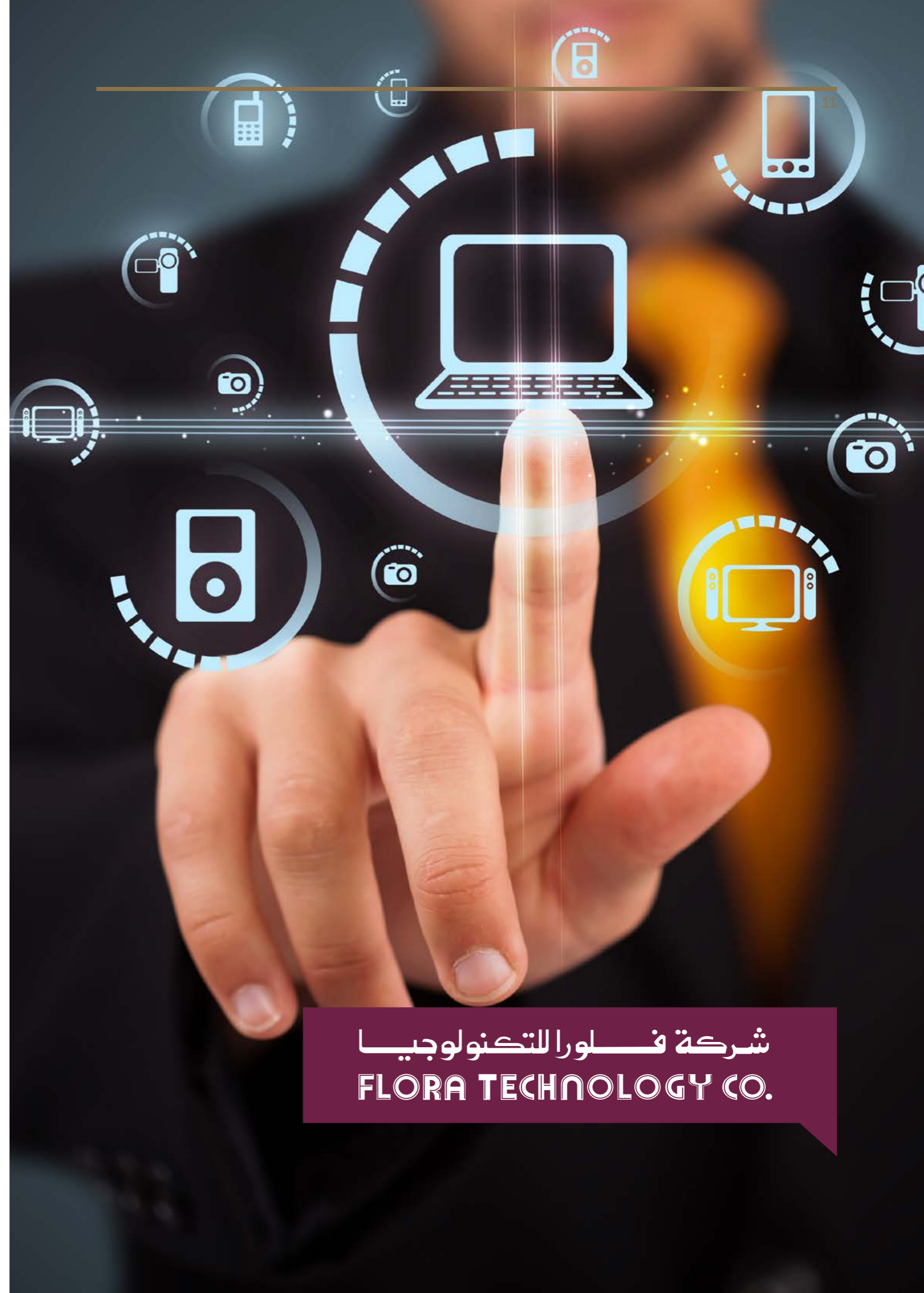

شركة فلورا للتكنولوجيا
FLORA TECHNOLOGY CO.



شركة فلورا للتكنولوجيا
FLORA TECHNOLOGY CO.

PREMIUM TECHNOLOGY FOR BUSINESS SUCCESS

Flora Technology Co. was established as a branch company of Flora Group and since our beginnings, we focused on providing state-of-the-art, end-to-end technology solutions and services to the Qatari governmental and private entities.

Over the years, we have developed the necessary expertise that allows us to provide our clients with highly customized advanced technology solutions, with a full range of services starting from the initial requirements and system analysis up to the end-user training and full maintenance and support passing by the implementation, installation, programming and custom software development stages.

As a Flora Group branch, we are strictly committed to the group's values, putting customer satisfaction as the center of our interests and striving to provide the best quality in every product and service that we provide. Our highly qualified and experienced group of professionals can drive innovation in your business with the commitment of our group's high professional and ethical standards.



OUR SERVICES

Our range of services extends from providing premium IT and technology solutions such as:

- Customer Experience Management
- Workforce Management
- Retail solutions
- Asset Management
- IT Infrastructure solutions

To the inherent range of services including:

- Installation and implementation
- Repairing and Maintenance
- Custom development and programming
- Training and support

OUR STRATEGIC TECHNOLOGY PARTNERS

At Flora Technology, we are the Exclusive partner in Qatar for the following brands :



PRODUCTS / SOLUTIONS

CUSTOMER EXPERIENCE:

- Queue Management systems
- Mobile Applications
- Online Appointment Booking
- Business Intelligence
- Customer Feedback Solutions

TIME ATTENDANCE SOLUTION:

- Fingerprint Time attendance
- Facial recognition Time attendance
- Proximity card Time attendance
- Time recoding terminals

POS & PRINTING SOLUTIONS:

- ID card printers
- D card software
- Point of sale
- In-counter scanner/scales
- On-counter readers
- Handhold readers
- Loss prevention / anti-theft solutions
- Receipt printers
- Ticket Printers
- Bar-code Scanners / Printers
- RFID Printers / Encoders
- Mobile computers
- Portable data collectors

NETWORK SOLUTION:

- Storage and backup
- IBM systems and servers
- Networking solutions
- IBM software solutions
- IP Telephony solutions
- Public address systems

CONTENT MANAGEMENT SOLUTION:

- IPTV Solutions.
- Digital signage.
- Way finding.
- Interactive self-service kiosks.

SOFTWARE SOLUTION:

- ON Time - Flora Time & Attendance System
- OSOOL - Fixed Asset Management System.
- FACE - Flora Advanced Customer Evaluation.
- Interactive Education Solutions
- Retail solutions
- Store automation solutions
- Student Registration Solution



CUSTOMER EXPERIENCE MANAGEMENT QMATIC

FLORA Technology as Qmatic Platinum Partner, offers market leading solutions within the Customer Experience Management (CEM) category designed to support great face-to-face experiences in your store, branch or hospital. Qmatic also offers innovative, efficient and secure integration gateways to other ecosystems to enable you to deliver seamless customer journeys.



QMATIC

Why Qmatic?

EXPERIENCE.

We are the world's largest supplier of Customer Experience Management solutions for the face-to-face meeting.

KNOWLEDGE.

We provide the glue between the online and physical world to allow you to provide seamless and personalized customer journeys.

WIDE RANGE.

We provide a full range of products all the way up to large scale enterprise solutions spanning many branches and countries.

FLEXIBILITY.

Our solutions are on-premise, off-premise, mobile or cloud based.

THE CUSTOMER FLOW MANAGEMENT PROCESS CONSISTS OF SEVERAL PHASES INCLUDING



PRE-ARRIVAL

Customer Flow Management (CFM) can start before the customer physically arrives by implementing a method to book appointments before arrival or use mobile solutions such as smartphone apps (mobile queue management).

ARRIVAL

On arrival, customers need to be placed in an appropriate queue. Customer Flow Management stresses the possibility of segmenting the customers in different queues if appropriate, rather than entering all customers in the same queue.

QUEUING / WAITING

A balanced and controlled waiting period is the desired optimum result of any manager. CFM can help managers get the balance just right by improving staff planning and by adding more flexibility to the processes.

SERVING

When the customer is being served, data of their visit can be captured and made available for real-time insight through management dashboards. CFM provides the ability to see these details and Alert mechanisms can give the manager the opportunity to take action if waiting times exceed preset limits.

POST-SERVING

After a customer has been served, staff closes the transaction and relevant data are recorded. Each step is documented and processed. It is also possible to engage the customer in other value-adding activities like answering customer surveys.

MANAGING

If data from the CFM process is gathered and stored then managers can, at any point in time, use that data to evaluate the current processes. Reports can be generated on employee/customer interactions, service times and customer wait times.

TIME AND ATTENDANCE SOLUTIONS

Our time and attendance solutions are designed to save your time and money by removing the manual process involved in completing your staff time sheets and updating your weekly payroll. Our market leading Devices for time and attendance system is widely used in many industries including Government, Retail, Manufacturing, Hotels, Contracting, and many more throughout Qatar.

We offer a variety of Biometric methods such as Fingerprint Face detection and Access cards to record the attendance of the employees and manage it in an easy to use software for monitoring employee's working times as well as to collect attendance information such as absence trends and costs which you can analyze to find better ways to increase productivity – not to mention, reducing administration costs and time.



RETAIL (BARCODE SOLUTION)

BARCODE SCANNING EQUIPMENT & HARDWARE

We provide a large selection of barcode scanners, verifiers and mobile computers. Whether you need a reader for 1D or 2D barcodes, rugged scanners, fixed scanners or general purpose, we have you covered.

MOBILE COMPUTER

Handheld, Industrial, Android, Windows, Rugged, & More Our Mobile Computers, portable data terminals, and handheld computers are the perfect multi-use tool for your advanced data capture and mobility needs. With options for batch and real-time wireless (Wi-Fi and Cellular) data capture, we have units for every application and environment. We also equip our mobile computers with Windows Embedded, Windows Mobile, Windows CE, or Android operating systems to ensure seamless software integration with your back-end systems. Lastly, our mobile devices come in a variety of form factors such as gun-grip, wearable and even some as small as your smartphone, while still maintaining a higher level of ruggedness and barcode scanning capability.

CORDLESS / WIRELESS BARCODE SCANNER

Cordless or Wireless Barcode Scanners use radio frequencies, or Bluetooth technology, similar to cordless phones to send scanned information back to a dock or cradle base station that is attached to a computer via a USB, Serial or other connection cable. The cordless range will vary by model from 33ft to over 200ft. Cordless Scanners Scanner can dramatically improve any application where a cable could get damaged or limit access to items being scanned.

ANTI-SHOPLIFTING SYSTEM

Preventative measures should be teamed with the technology of an Electronic Article Surveillance security system in your store for maximum anti-theft protection for retailers of all sizes.

- Apply security tags to all high-shrink merchandise. The tag will alarm on exit if it has not been removed by the sales assistant
- Security tags are the perfect anti-shoplifting device as they are a clear and visible deterrent for shoplifters, while unobtrusive to customers
- All types of merchandise can be "tagged" and is therefore a viable option for any retailer
- A system can be suited for all budgets, locations and store fit-out

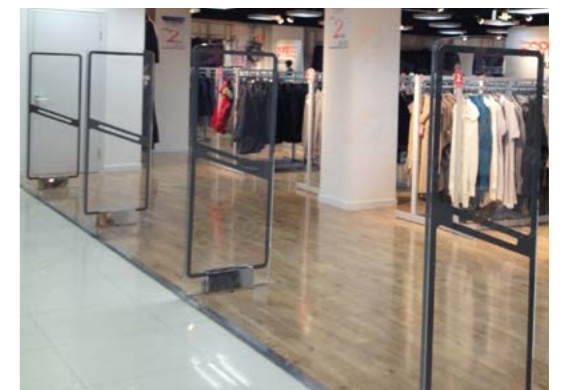

POINT OF SALE SYSTEMS

RECEIPT PRINTER

Restaurants, banks, retail and other heavy-use environments will benefit from our wide selection of high-speed thermal and impact journal, slip, validation and Receipt Printer. Whether you need a desktop, mobile, or kiosk based printer, we have a model to meet the demands of any business.

Desktop Receipt Printer come with a variety of options to support any POS system. Thermal and impact models ensure the highest quality print at speeds to keep up with your busiest days. With models that support basic receipt printing, check validation, or slip printing, we have a printer to support any of your POS printing needs.

BARCODE LABELS & RIBBONS:

We also provide direct thermal or thermal transfer barcode labels, ribbon, RFID tags, and shipping labels that are commonly used. We carry hard-to-find label sizes and custom labels specific to your application.



ID CARD SOLUTIONS

The first step in making an effective ID card system is choosing a printer that will meet the demands of your application. Making a high quality PVC card requires the right type of printer with support for the security features your business needs. Shop our selection of Datacard, Fargo, and Zebra printers.

SINGLE-SIDED ID CARD PRINTER

- Print on one side of an ID card
- Full-color or monochrome printing capability
- Magnetic stripe and smart card encoding options
- Direct-to-card or stunning reverse transfer printing technology
- Some models upgradeable to dual-sided printing or lamination

DUAL-SIDED ID CARD PRINTER

- Ability to print on both sides of an ID Card
- Full-color or monochrome
- Magnetic stripe, smart card and contactless encoding options
- Direct-to-card or stunning reverse transfer printing technology
- Some models upgradeable to lamination

LAMINATING ID CARD PRINTER

- Extend the life of your ID Card with lamination protection
- Added security from forgery
- Full-color or monochrome
- Magnetic stripe, smart card and contactless encoding options
- Direct-to-card or stunning reverse transfer printing

RETRANSFER ID CARD PRINTER

- Bright vibrant color images
- Produce "Over-the-edge" image coverage
- Available in single or dual-sided printers
- Card surface interruptions such as smart chips, ridges caused by internal RFID antennae and debris do not affect print quality
- Magnetic stripe, smart card and contactless encoding options



DATACENTERS SOLUTIONS

SWITCHES

Adapt your network to meet evolving business requirements and optimize new application deployments, we provide innovative switching solutions to consumers, business and service providers. For small to Large organizations, our solutions vary from Unmanaged, Web Managed (Plus) and Smart Managed Switch solutions which are easy to use and install.

SERVERS AND STORAGE

Drive your business forward with a server that matches your needs. Reduce costs and complexity by investing in a system that handles today's workload and expands to accommodate future growth.

We offer a full spectrum of tower and rackmount scalable storage servers for data backup, near line storage, media sharing storage, CCTV storage, content creation, streaming media and post-production solutions.

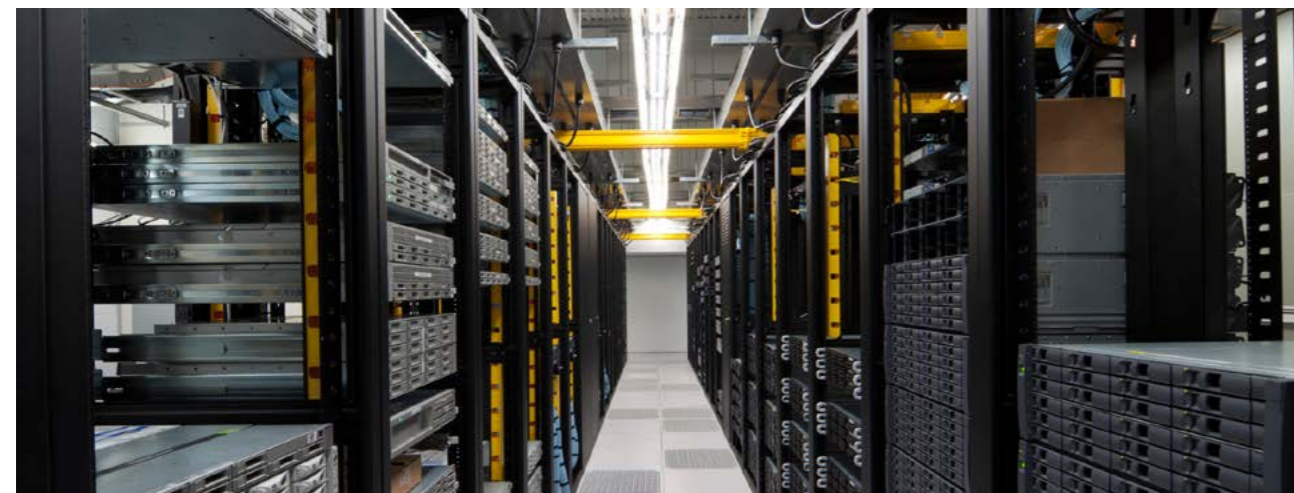

STRUCTURED CABLING

Whether you're building a new location or want to upgrade your existing infrastructure, we provide your needs for your cabling projects, specialize in voice, data, and fiber optic cabling based on reliable, high-quality, standards-based cabling and network infrastructure components. Whether implementing a new or upgraded LAN, or rolling out a new technology, having a network cabling system that is able to scale to accommodate bandwidth needs and easily integrate the latest technologies helps your business stay competitive, while reducing overall infrastructure costs.

UNINTERRUPTIBLE POWER SUPPLY (UPS):

In today's 24/7 on demand world, mission-critical business systems must be available 100% of the time. Downtime cannot be tolerated, which is where an uninterrupted power supply can assist. We deliver industry-leading power protection solutions combined with service excellence to ensure systems are 'Always On'.



MONITORING SYSTEM

- Know Immediately if And when Problems Arise
- Reduce or Eliminate Downtime
- Maintain Maximum Energy and Resource Efficiency
- Maximum Reliability for Users and Peace-Of-Mind for Managers
- Protect and Extend the Life of Equipment's, product & Property
- Stay online & Open for business
- Cloud Sync & Centralized Management

WIRELESS LAN SOLUTIONS:

A Wireless LAN Solution Delivering What Matters Most: a High-Quality User Experience

- Deliver wired-like performance and predictability to your mobile users.
- Get application-level visibility and control
- Protect your investment with an upgradeable wireless solution that is robust and simple to operate.
- Reduce your equipment requirements and costs.
- Increase productivity and effectiveness.



CONTENT MANAGEMENT SOLUTIONS

IPTV:
Our IPTV solutions can be adapted to meet your specific requirements. IPTV can be seamlessly integrated, thus increasing the range of content available for your guests and enhancing their overall entertainment experience.

Additionally complete stand-alone professional IPTV solutions are offered to customers who do not have an in-room system, and our services include the supply, installation and maintenance of the latest digital TV equipment.

DIGITAL SIGNAGE
Digital signs are used in wayfinding, exhibitions, public installations, marketing and outdoor advertising. Digital signage displays use content management systems and digital media distribution systems which can either be run from personal computers and servers or regional/national media hosting providers.



SELF SERVICE KIOSK:
Our portfolio consists of standardized and customized Kiosk systems & Self-service Solutions. Our application development is being done in-house.

In the ever-accelerating world of nowadays, for many people, time is of the essence. We help improving current business processes, by transforming them from labor intensive procedures into fully automated self-service operations.



SMART PODIUMS

E-podiums are the perfect addition to schools, colleges, universities, auditoriums, or any location where presentations are given. They provide a safe and convenient means to store and use a wide range of audio/visual equipment.

- Different sizes, Shapes and options
- Standard and motorized heights available
- RFID Card reader
- Complete Audio Visual System with Microphones, Mixers, speakers, Switchers and LCD touch screens
- Room controller with Touch LCD.
- Master Management Software for Multi Unites master control.

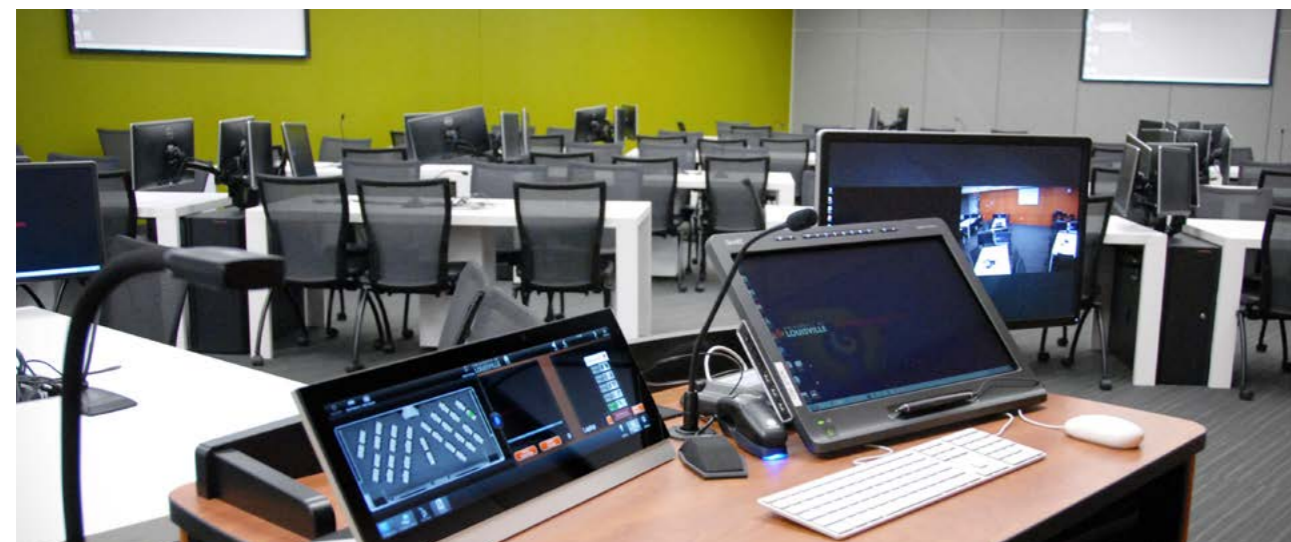

IP SOLUTIONS

IP TELEPHONY

IP telephony provides a way for you to extend highly secure, reliable, and consistent communications services to all your employees whether they are in main campus locations, at branch offices, working remotely, or are mobile. IP telephony transmits voice communications over the network using open-standards-based Internet Protocol.

- Provide highly secure, reliable, scalable communications that take advantage of your LAN and WAN
- Improve employee agility and productivity through integration with innovative Unified Communications and third-party applications.



IP CLOCK

IP PoE clocks are trusted to keep accurate, synchronized time in schools, major universities, hospitals, government offices, manufacturing facilities, contact centers and corporate environments around the world. See our selection of Digital and Analog clocks.



PUBLIC ADDRESS

For your school, business, or organization, our Public address systems offer a variety of multimedia options for announcing important notifications.

Public Address systems are recognized as highly effective and low cost methods of communicating information to a large area or group of individuals quickly. With systems ranging from simple microphone and speaker arrangements to full evacuation systems, there are many ways we can develop solutions to meet a requirement.



INTERACTIVE EDUCATIONAL SOLUTIONS

FUTURE OF DIGITAL TEXTBOOKS

While, on one side of the system, there are the pupils who experience the digital boom as an adventure in their everyday lives and have a gradually increasing need for digital education, on the other side, there are masses of teachers sticking to the traditional curriculum, slowly becoming accustomed to digital tools. And so these teachers feel increasingly uncertain, as if they were being left alone.

If, in the meantime, the stakeholders in education do not offer a solution, or are stalling, the gap between teachers and pupils will continue to grow: the effectiveness of education and morale declines on both sides.

INTERACTIVE BOARD SOFTWARE SUITE

mozaBook is a presentation software optimized for use on interactive boards in the classroom. Teachers and students can create presentations and enrich them with interactive 3D scenes, educational videos, images or exercises from our Media Library or from their own files. mozaBook includes a variety of teaching resources, such as thematic applications, games and 3D models covering all K-12 subjects, which raise students' attention and help them better understand the topic.

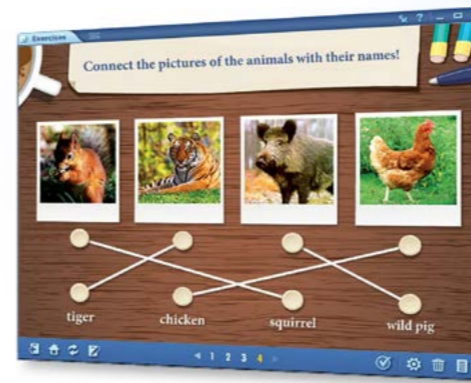

IN HOUSE SOFTWARE

ON TIME - FLORA TIME & ATTENDANCE SYSTEM

Flora Time and attendance solution helps you manage various challenges in employee attendance management with ease. The technologically advanced, yet simple and comprehensive bilingual solution provides a convenient way to track your employee's time and attendance and monitor productivity. The solution also empowers you to manage centralized shift management, multiple employee location and different timings, formatted reports to reduce time spent on payroll calculations.

ON Time Flora Time & Attendance System.

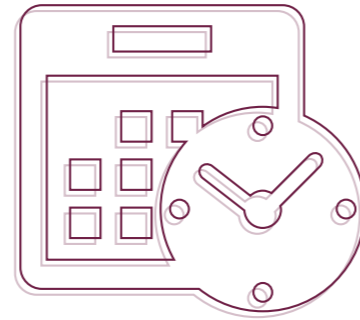

ORGANIZATION MANAGEMENT

- Manage group of companies in a single solution
- Manage departments
- Edit company profile

EMPLOYEE MANAGEMENT

- View employee profile
- Flexible time rules and policies for employee groups
- Exempt senior management from attendance

SHIFT MANAGEMENT

- Various time rules for shift rooster
- Shift time in and out
- Grace periods

LEAVE AND HOLIDAY MANAGEMENT

- Various time rules for shift rooster
- Shift time in and out
- Grace periods

PERMISSION AND APPROVALS

- Request Permission to take off for few hours
- Request Leave
- Manage Approvals

MULTI LOCATION DATE

- Easy date management - USB / LAN
- Collect data from multi location
- Punch in multiple devices
- User friendly devices

REPORTS AND EMAIL ALERTS

- View in and out reports
- View Dashboards
- Shedule Reports

HRMS INTEGRATION

- Integrate with HRMS and Payroll systems
- Manage employee profile through integration
- Manage Leaves through Intergration

OSOOL - FIXED ASSET MANAGEMENT SYSTEM

Flora's Fixed Asset Management System is a one stop solution for all your countless brands of fixed assets. It is a simple UI based application which affords you with a systematic process for managing, maintaining and upgrading your physical assets electronically. It allows companies to track their assets, where each is located, who has it, when it is due for return, when it is scheduled for maintenance, the cost and depreciation of each asset... etc. The application also promotes the Go Green concept.

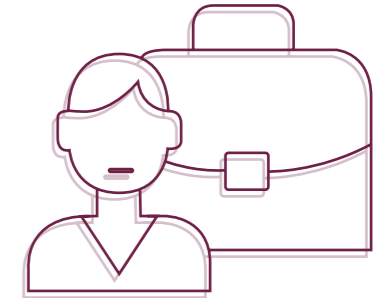

ASSET MANAGEMENT

- Vendor Profile
- Product Management
- Purchase Order
- Asset Manager
- Maintenance
- Disposal
- Location Details
- Depreciation

EMPLOYEE MANAGEMENT

- Employee Profile
- Manager Approval
- Admin Approval
- Asset Tracking

DASHBOARD

- Consolodated overview of fixed asset details

PDA APPLICATION

- Audit/ Transfer Asset
- Assign / Verify Location

APPLICATION SETTINGS

- Multi Language
- Company Settings
- User Profile
- Roles

ROLES

- Employee
- Manager
- Admin

REPORTS

- Default Reports
- Customized Report
- Schedule Report

LOGS

It allows you to outlook the status of each stayed pages

Osool Asset Management System Fixed



FACE - FLORA ADVANCED CUSTOMER EVALUATION

- Flora Survey Management System and Feedback Solutions offers complete control of your target lists, survey design, analysis and reporting
- Question format - ask a question in any format, layout and arrangement
- Reusing resources - Flora Survey Management System and Feedback Solutions encourages re-use of surveys, questions, lists, headers/ footers etc.
- Applications - in addition to regular surveys, Flora Survey Management System and Feedback Solutions can provide the technology for; easy tests, user registration, Complaint Form, etc. The database is openly available, and can be integrated with other systems



SUPPORT & MAINTENANCE CONTRACT

Flora offers technical support to more than 1000 clients all over Qatar. Also, as we are keen on helping our clients with round-the-clock assistance, we have created a 24X7 call center, and 20 support teams which are fully equipped with the knowledge and the necessary tool and trained by our international partners.



+974 44311905

support@floragroup.net



فلورا للأمنظمة الأمنية
FLORA SECURITY SYSTEMS



فلورا للأمنظمة الأمنية
FLORA SECURITY SYSTEMS

Ensuring unbreached security is becoming a necessity in all sectors across the world. With the increasing risk of theft, break-ins, accidents, vandalism, sabotage and other physical hazards, protecting people and properties and controlling the increased flow of people is becoming a prerequisite to ensure any business continuity and profitability.

Taking cognizance of this necessity for security and to help clients address the growing demand for protection, Flora Group officially registered the Flora Security Systems branch in 2013 as a Qatari security specialized and MOI certified company. Our access control, video surveillance and other innovative security products continue to offer the same level of service and quality which are characteristic of Flora Group since its inception in 1993. Today, Flora Security Systems is doing a great deal to meet the growing need of protection among its customers and to exceed their expectations in this particularly sensitive field.

We meet our customers' needs with focused security solutions that give them the greatest possible benefits in terms of security, organizational efficiency and convenience, thus helping them protecting the things that matter.

Our strategic technology partners
Apart from reselling and installing other brands, Flora Group is the leading distributor in Qatar for the following brands



OUR SERVICES

Flora Security Systems offers innovative solutions and services in these domains:

• Video Surveillance

Flora Security Systems is officially certified by the Qatari Ministry of Interior - Security System Department (SSD) and qualified to execute any kind of CCTV Projects as per MOI regulation. We are also a Gold partner and sole distributor for Axis communications products, the leading provider of video surveillance systems

• Access control and Physical access systems

Access control helps customers provide employees, subcontractors and visitors the correct level of access to the appropriate facilities at the right time. Our range of products for integrated access control systems is complemented with support services such as security consultation, customization and maintenance.

OUR STRATEGIC TECHNOLOGY PARTNERS

Along with other brands that we are reselling and installing, we are the Exclusive distributor in Qatar for the following brands :

GOLD PARTNER



SOLE DISTRIBUTOR

GRANDING

Gantner
technologies

sensor
ACCESSTECHNOLOGY

PRODUCTS / SOLUTIONS

SECURITY SOLUTIONS:

- IP Network Cameras.
- Video Management software.
- Access Control System.
- Facial Recognition.
- E-Gate System.
- Turnstiles.

NETWORK IP SURVEILLANCE SYSTEM

Axis offers the market's broadest and most consistent range of high-quality network cameras. Axis' cameras cover a variety of application needs, from robust outdoor cameras for harsh climates, to discreet products for sensitive environments.

The cameras provide a number of capabilities – HDTV, wide dynamic range, infrared and Lightfinder to name a few – which ensure clear video even in difficult lighting conditions. Axis' cameras also provide advanced video analytics features, such as motion detection, audio detection and tampering alarm.

FIXED NETWORK CAMERAS

A fixed network camera is a camera that has a fixed viewing direction once it is mounted. It may come with a fixed, varifocal or motorized zoom lens, and the lens may be exchangeable on some cameras.

Axis' indoor and outdoor fixed camera offerings include the traditional camera type where the camera and the direction in which it is pointing are clearly visible, as well as highly discreet cameras that are designed to blend into the environment and be difficult to discover.



AXIS[®]
COMMUNICATIONS

Arecont Vision

HIKVISION

VIDEO MANAGEMENT SYSTEM (VMS)

Intelligent video management providing a single software platform for:

- Future-Proof Surveillance - With multiple software license versions to choose from, we have solutions for every stage on the migration path from analog CCTV to intelligent IP video. And, with the industry's simplest licensing model, transitioning is easier than ever.
- Open IP Video Management - installs on standard IT hardware, supports hundreds of camera models, provides a feature-rich, easy-to-use interface, and has a full Application Programming Interface (API) that makes integration with third-party systems, such as access control, easy.
- Proven Video Analytics - video analytic algorithms are seamlessly incorporated to analyze video data in real-time and provide organizations with intelligent information at their fingertips.
- Security & Beyond - With advanced video search tools, and a comprehensive selection of on-demand reports, organizations use VMS for business intelligence in addition to security surveillance, helping them to better plan business requirements, improve operations and increase ROI



ENTRANCE MANAGEMENT SYSTEMS

ACCESS CONTROL:

Our access control starts with a platform that can scale to the needs and ever-changing environments of businesses today. Our solutions range from entry-level to enterprise systems that provide the flexibility and performance expected from a technology-driven security company.

Designed to work together seamlessly, Access Systems' products provide you with the technology you need to deliver sophisticated security solutions—from the simplest to the most challenging.

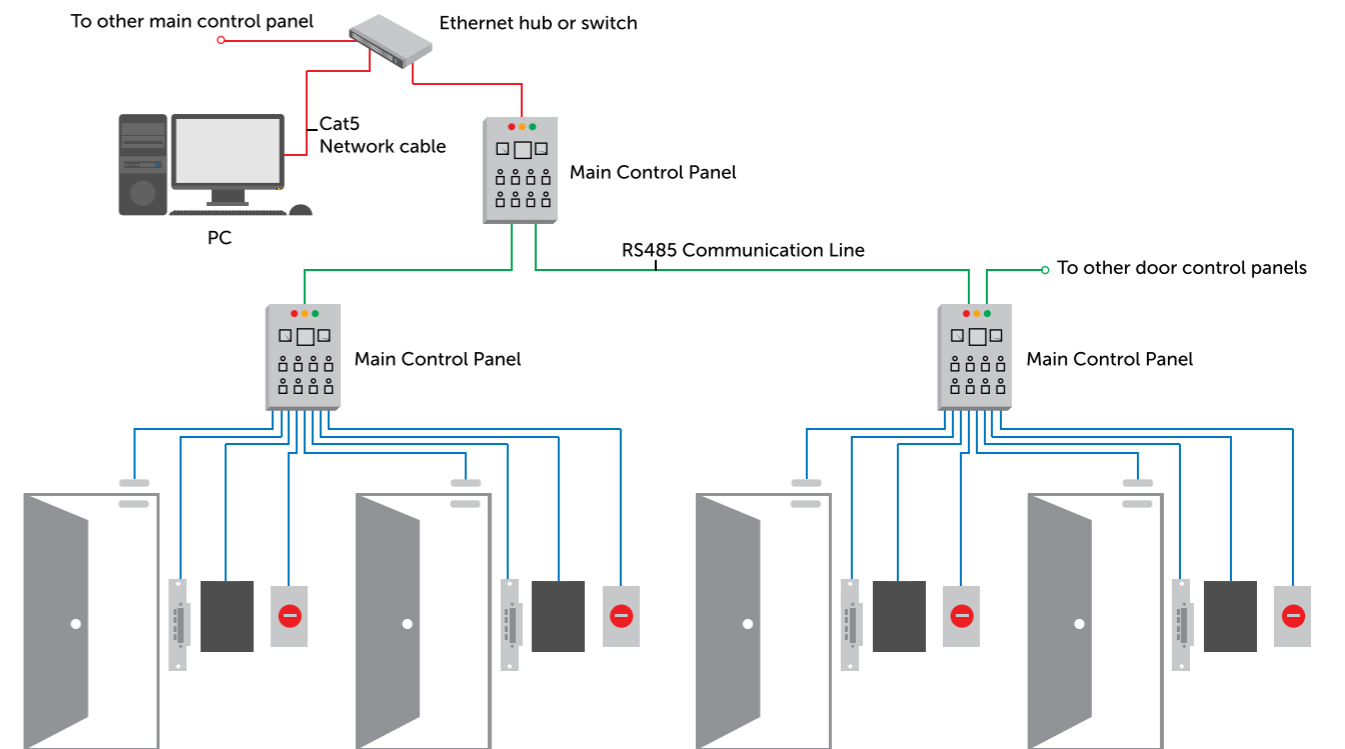

PARKING CONTROL SYSTEMS

Modern parking management

- Stress-free and convenient parking for your customers
- Revenue maximization using e-commerce options such as booking and reservation platforms
- Target group-adjusted marketing using reports and analyses of behavior
- Efficient and cheap operation due to the highest level of reliability
- Easy integration into the organization systems and structures

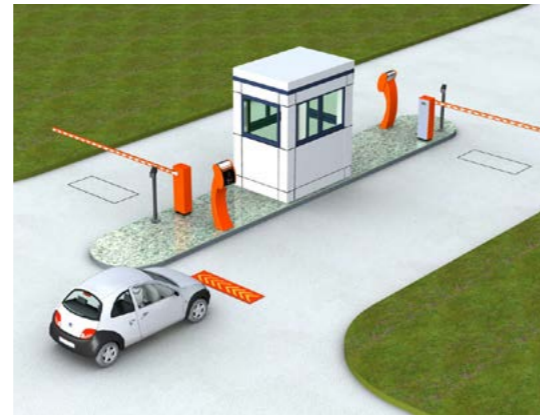

E - GATE

EGate entrance and exit systems. Cutting-edge technology for regulating the flow of people at entrances or exits. Barrier-free passage with variable access widths.

EGate control system. Entrance and exit system with innovative inspection system for access authorization and visual and acoustic alarm management in the event of misuse. The seamless, efficient and simultaneously fast check of the access authorization is done on the integrated scanner – meeting the highest of safety requirements.



ÖZAK
TURNİKE-TURNSTİLE

OUR TOP CLIENTS

Government



Health care



Finance



Others





FLORA GROUP

Flora Building, Rawdat Al Khail St,
Al Helal, Opposite Qatar Chamber
Doha, Qatar, P.O. Box: 16118

Tel: (+974) 44311905 | 44314181 | 44553303

Fax: (+974) 44314133 | 44369778

Email: floratechnology@floragroup.net | floraqatar@qatar.net.qa

www.floragroup.net